

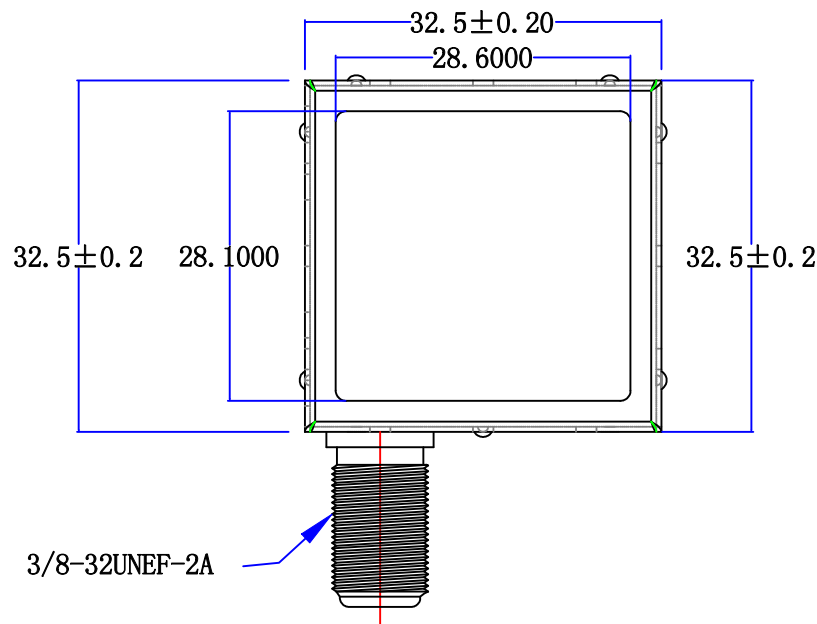

Product NO.	Renhotec-611-0012			
REV	DESCRIPTION	DWN	DATE	APPROVEN
A	First issue	Mr. CHEN	2016/3/12	John kine

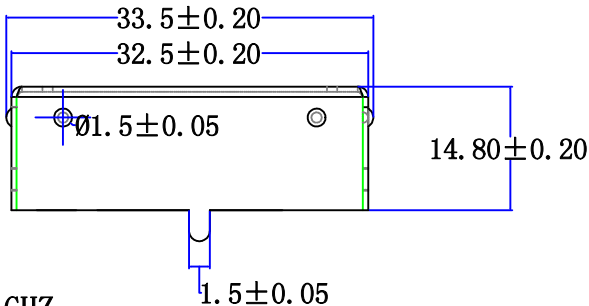
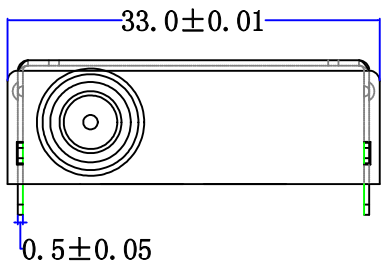

SPECIFICATIONS:

Impedance: 75 Ohms
 Frequency Range: DC~3G
 VSWR: 30dB Return loss @ 1GHZ
 Working Voltage: 15 watts continuous
 Insulation Resistance: 5000 Ohms min
 Temperature Range: -40°C TO +60°C
 Drawings products are in line with ROHS standards

1	F Body	BRASS	NI
2	HOLDER	IRON	SN
3	SHIELD	IRON	SN
4			
5			
6			
7			
8			
9			
10			
NO	Component Number	Material	Finish

NOTE:

DRAWN Zelin.Zhang 2016/03/12

CHECKED

APPROVALS John Kine 12/03.2016

Tolerance	0-6 ±0.10 6-30 ±0.20 30-120 ±0.30 Angular ±2°
View	
UNIT	MM
SCALE	1:1

RENHOTEC www.renhotec.com

RENHOTEC GROUP

Name: F Jack With Holder

SIZE A	Product NO. RENHOTEC-611-0012	REV B
DateTime 2016/3/12	CAD FILE D/company drawings/BD	SHEET: 1 OF 1