

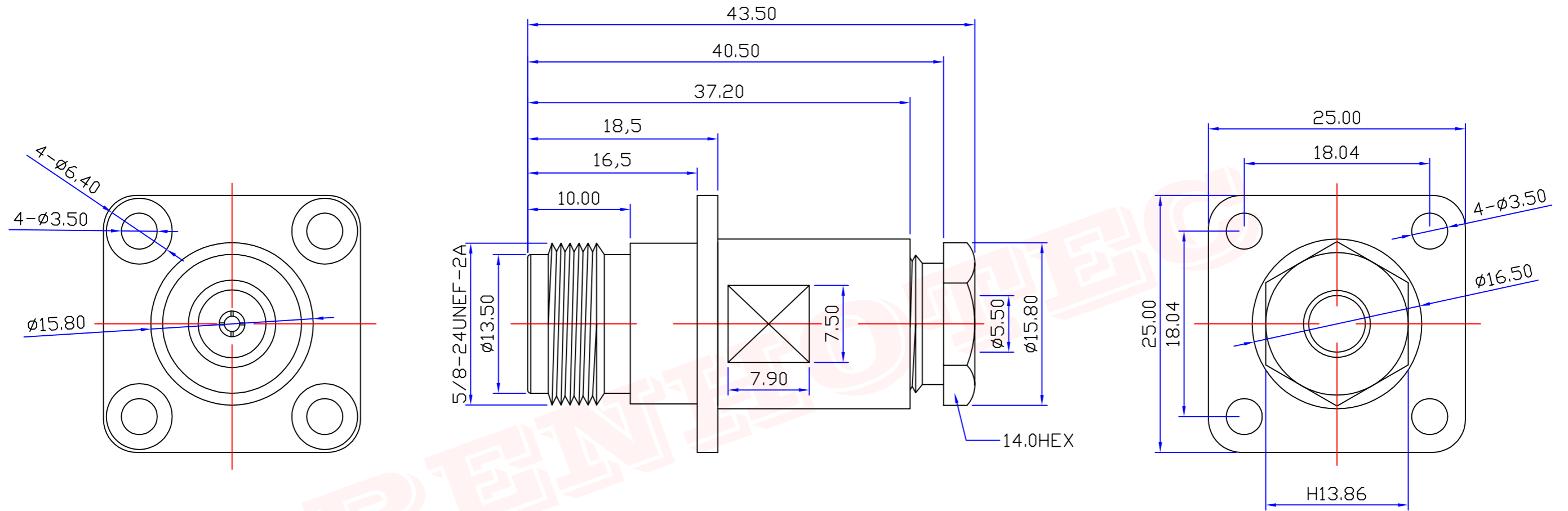

Product NO.		RHT-614-0193		
REV	DESCRIPTION	DWN	DATE	APPROVEN
A	First issue	Gavin	2018/03/12	JIM. KING



**Specifications**

Impedance: 50 Ohms  
 Frequency Range: 0-11G  
 VSWR: 1.3MAX  
 Working Voltage: 1000 VRMS (max at sea level)  
 Dielectric Withstanding Voltage: 1500 vrms (max at sea level)  
 Insulation Resistance: 5000 Ohms min  
 Durability Mating: 500 Cycles min  
 Temperature Range: -65°C TO +165°C

3	PIN	BRASS	GOLD	1
2	INSUKATON	TEFLON	WHITE	1
1	BODY	BRASS	NICKEL	1
NO	DESCRIPTION	MATERIAL	FINISH	QTY

-TOLERANCES- UNLESS OTHERWISE SPECIFIED	<b>RENHOTEC GROUP</b>				
	PART DESCRIPTION: Female N Type JACK For RG58 Cable				
UNLESS OTHERWISE SPECIFIED TOLERANCES FOR MILLIMETERS ARE: 0.5 - 8mm ± 0.20mm 8 - 30mm ± 0.40mm 30 - 120mm ± 0.50mm	Appd: JIM. KING	P/N: RHT-614-0193			
Check:	Date	Scale	Unit	Type	Page
Draw: Gavin	2018/03/12	Free	MM	Z	1/1